



Alcatel 'Test Module' by Roger Ray G8CUB

It wasn't until I was looking for something to help me tune up the Pasolink 50 transceiver on 47GHz, did I discover this little module. It had been sitting discarded, in my junk box, since building a 24GHz Alcatel based transverter. It is originally situated on the coupler in the Alcatel ODU. It is used as both a detector, and a method of providing 'loop round' normally being fed from a dedicated synthesiser at 1008MHz (difference frequency between Tx and Rx).

In one go it answered my requirements for an RF detector, harmonic multiplier, and most surprisingly a harmonic mixer. Its use at 24GHz, I later found had been given in an article by G4JNT #. Operation as a detector / multiplier at 47GHz and 76GHz was less obvious, and performance as a harmonic mixer a revelation

Use as a Detector

24G Detector

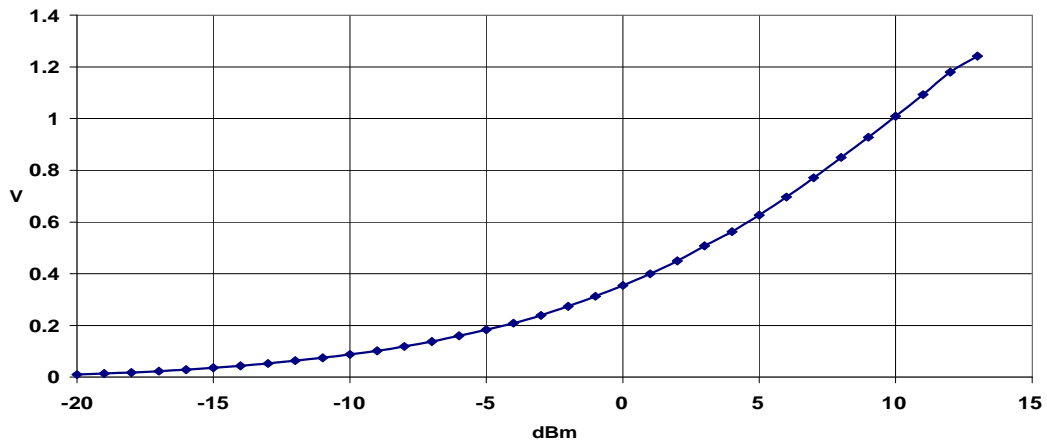

Dynamic range -20 to +13dBm. Measurement was simply made by connecting a DVM onto the detector SMA output. Input via an SMA wg-42 transition.

On 47Ghz output was 0.15V for around -10dBm in.

Use as a Multiplier

The multiplier input can be driven up to about 2.1GHz, drive +10 to +17dBm. A multiplication of X12 worked well for 24GHz. The drive level required for optimum output changes with frequency / multiplication. It is not linear with power, expect peaks around +10, +14, +17dBm input.

The detector input, can be driven as a multiplier up to at least 5Ghz level +8 to +17dBm. Output is good at 24GHz, and detectable up to 5 metres away on 47GHz (I used a multiplication of X23), and should be detectable at 76GHz. In practice it is easy to try each of the 2 inputs, and see which is better for the output required. Although at 47GHz the 'det' input definitely gave the best results.

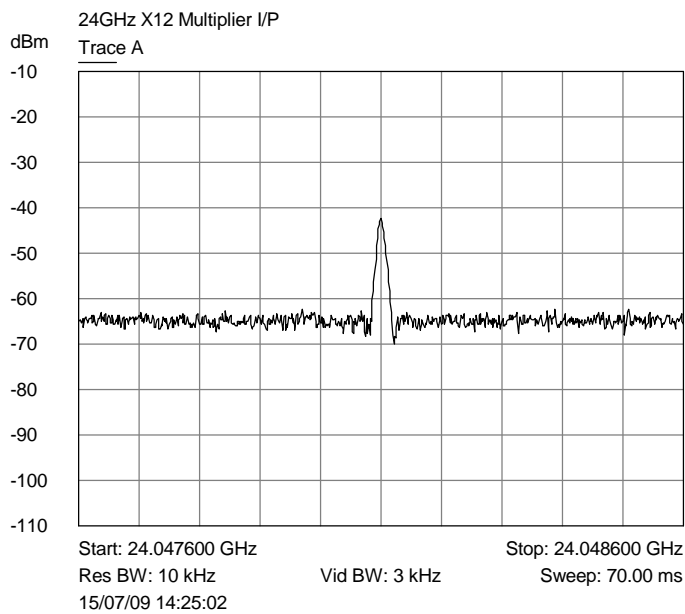

Use as a Harmonic Mixer

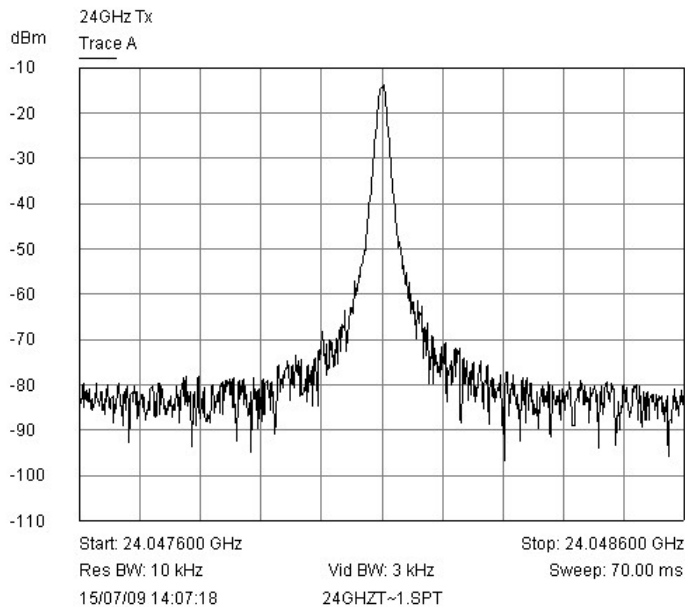

The plot shows the module being used as a harmonic mixer on an Advantest R3271 spectrum analyser. Although the analyser will work at 24GHz, in this case it is in external mixer mode. A single connection is used between the analyser and 'Det' SMA on the module. LO drive and IF input are on one coax, as the analyser contains an internal duplexer. Trying to use LO on the 'mlt' input, and using 'det' as an IF output did not work.

For use with an HP8566A or later analyser, a duplexer will be required. A simple duplexer is shown below. I made the IF filtering to cut off around 450MHz. The construction is more important than the actual component values. The inductors were about 8 turns 3mm dia. of fine wire, pulled around to get the best performance at 432MHz. I added a miniature ferrite on L1 to damp a resonance.

Block diagram

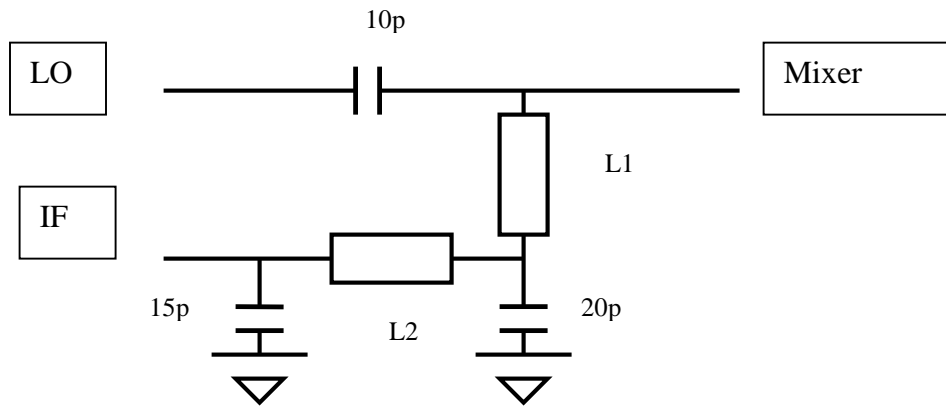

LO / IF Duplexor for HP Analysers

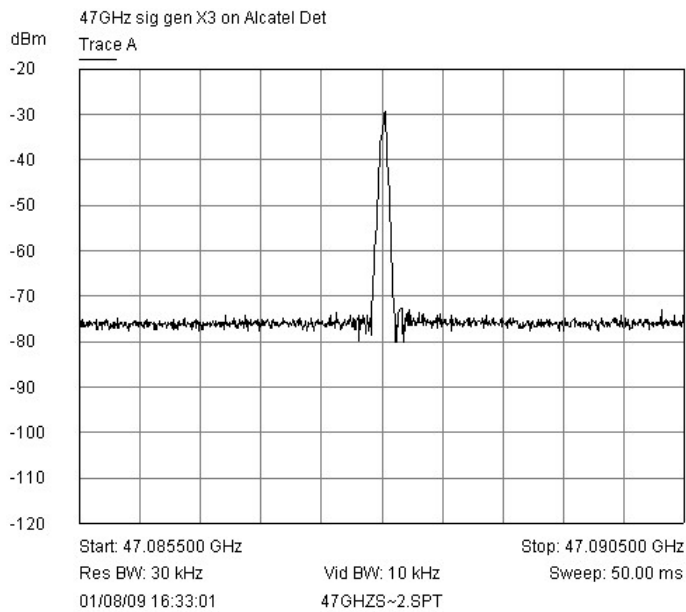

Harmonic Mixer with 0dBm 47Ghz input

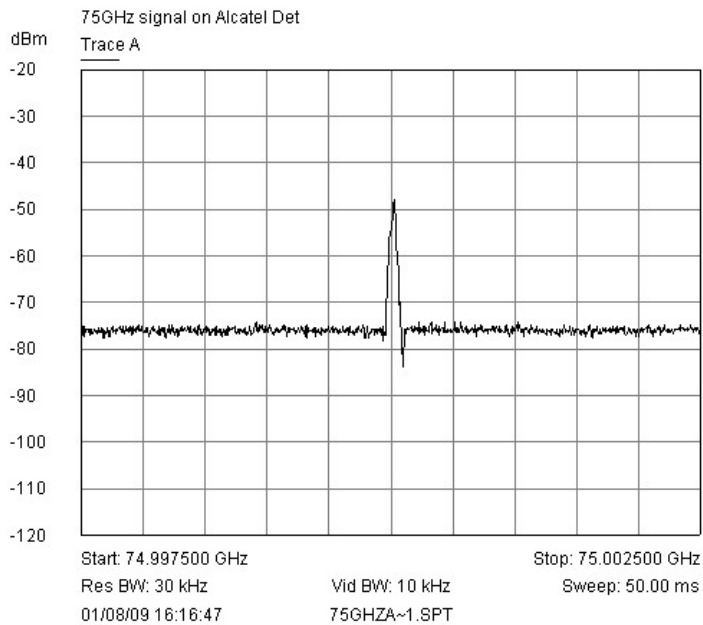

Harmonic Mixer with 75GHz input

I was surprised how well it worked at 75GHz (it works at 76GHz but my X5 source drops off 10dB unfortunately). Input was via 4 inches of wr-10 waveguide, just to make sure it really was 75GHz.

It would be fairly easy to add a tuning screw in the back panel to see if better performance at specific frequencies could be obtained. Using it as a mixer and external duplexer I could listen to my 47Ghz transmission using 432MHz as an IF.

The plots taken on the R3271 analyser are with approx. 15dB internal attenuation removed, as it was converted to remove the internal diplexor.

Internal construction

– the small black blobs are the diodes, the bit looking like 2 back to back Ds in a dark background is the coupler. The printed inductor – bottom left, forms a LPF limiting the input frequency of the ‘MLT’ input.

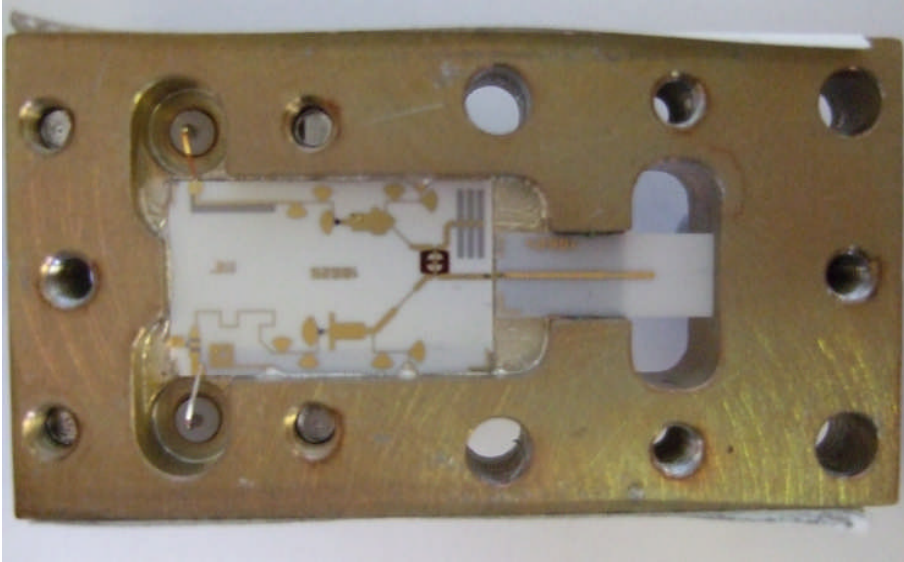

www.g4jnt.com/whiteboxmods.pdf